



15



XM
845-3/1

1

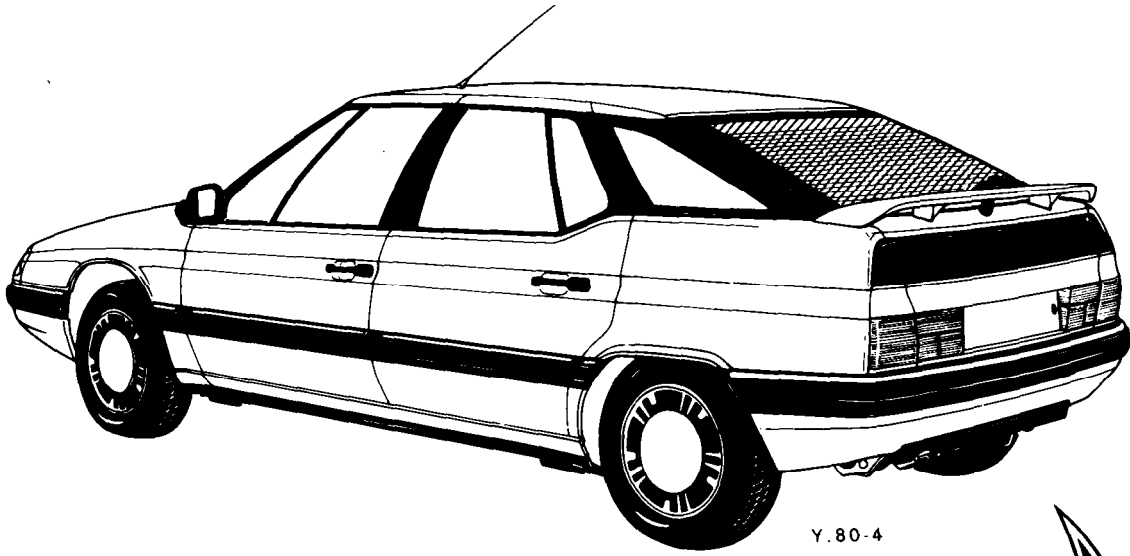

Y.80-4

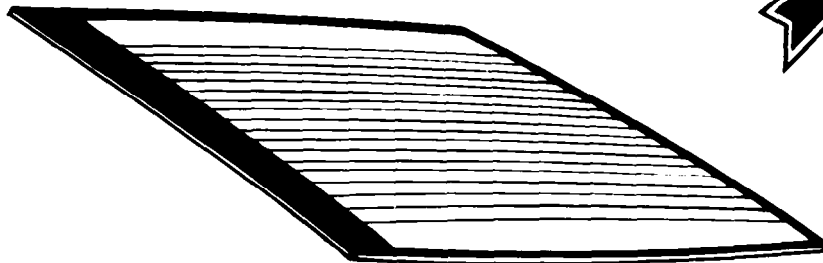
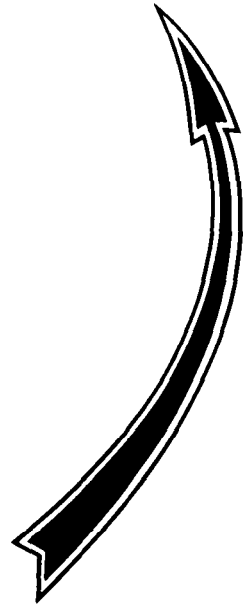

Y.80-8

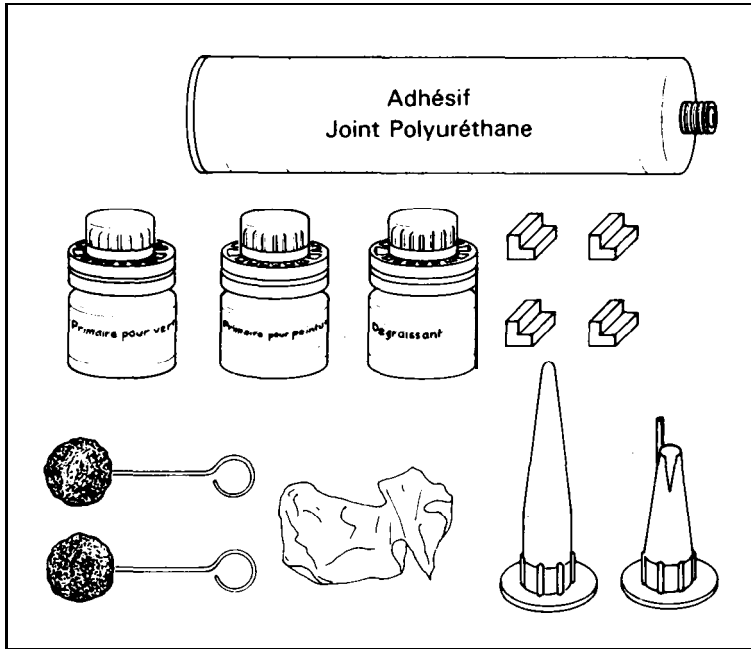
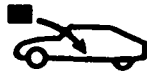
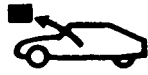

TT-96.10



A3

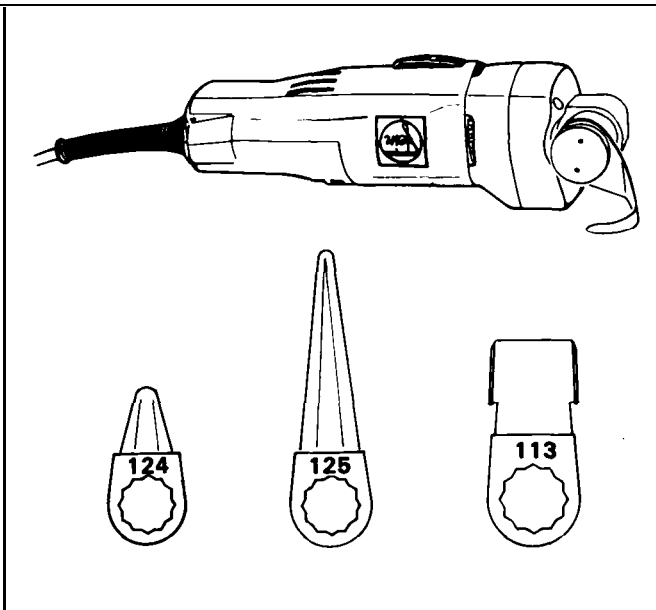

TT-96.11

TT-96.9

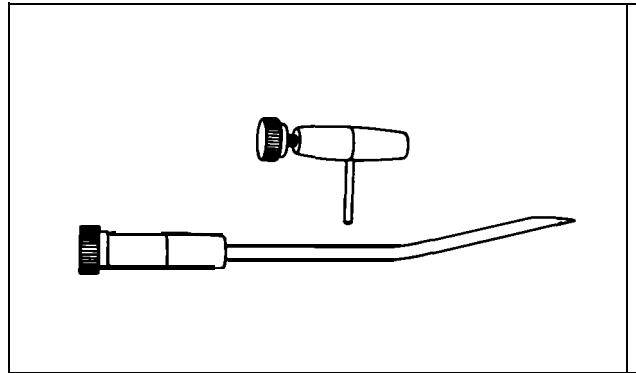

TT-96.7

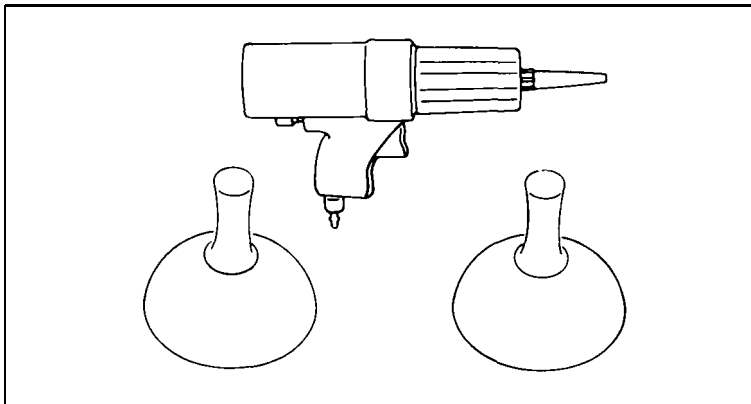

TT-96.7



15

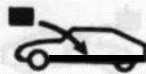
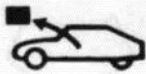

XM
845-3/1

3

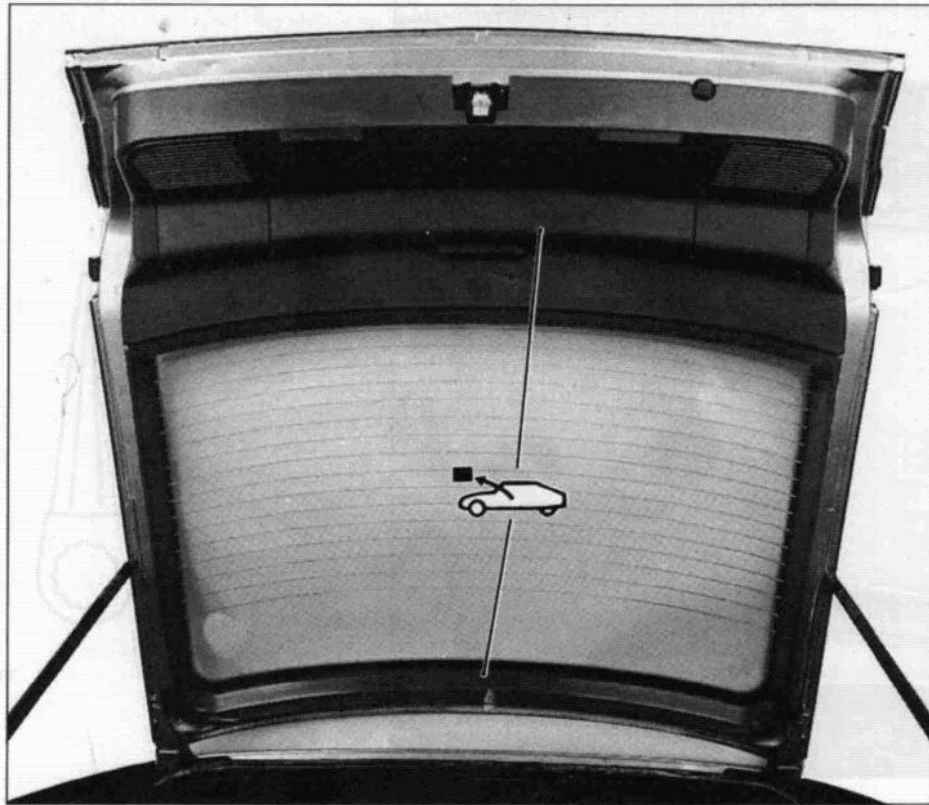

88-933

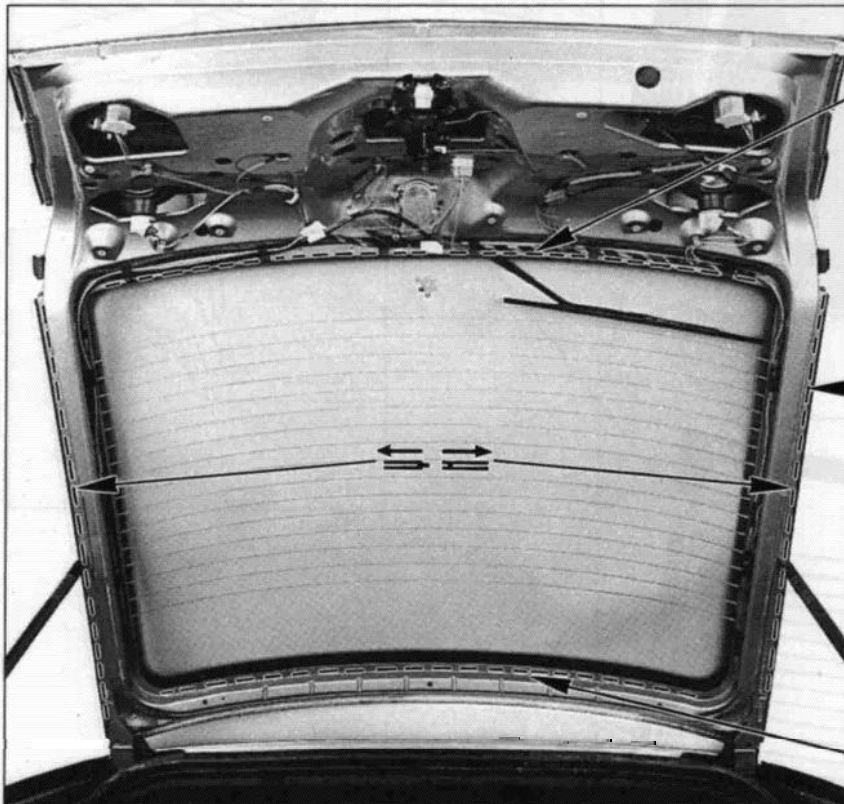

88-935

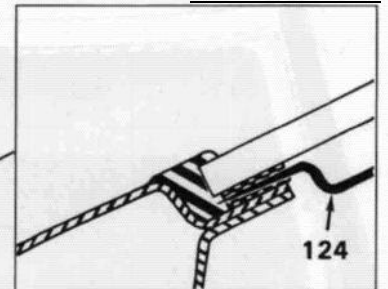

Y.96-6 (4)

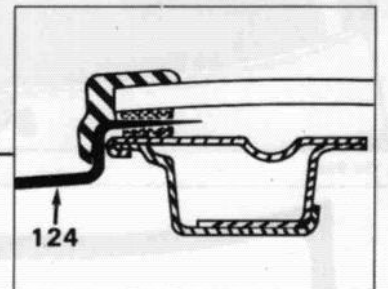

Y.96-6 (6)

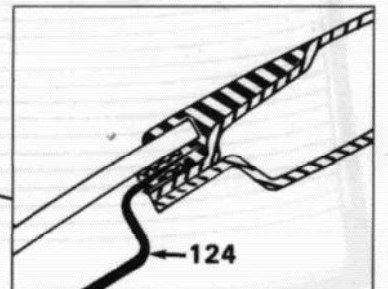

Y.96-6 (5)

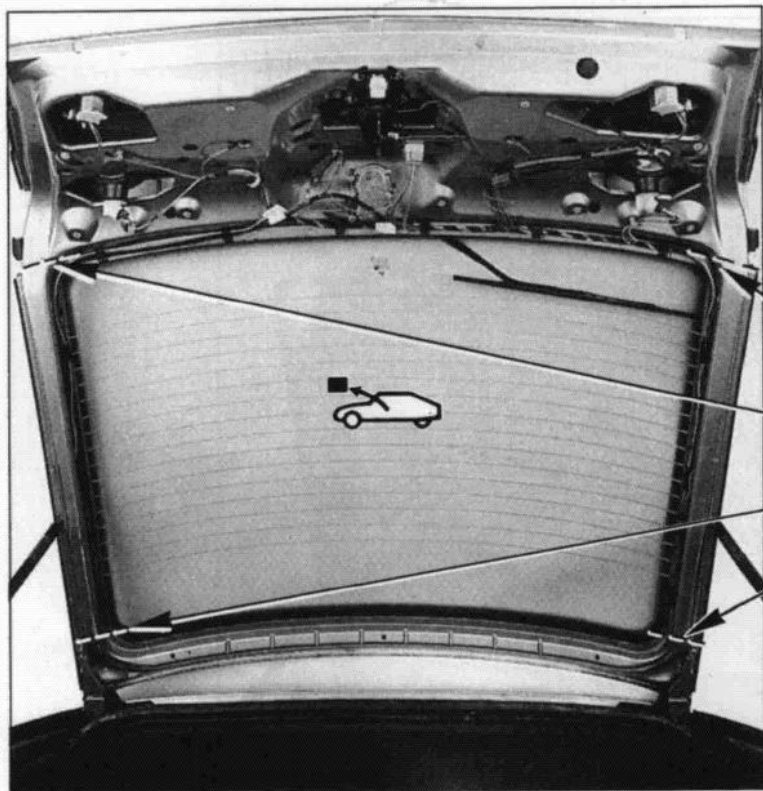
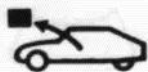

88-935

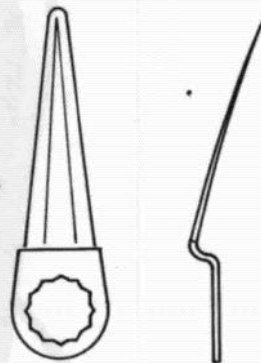

TT.96-11

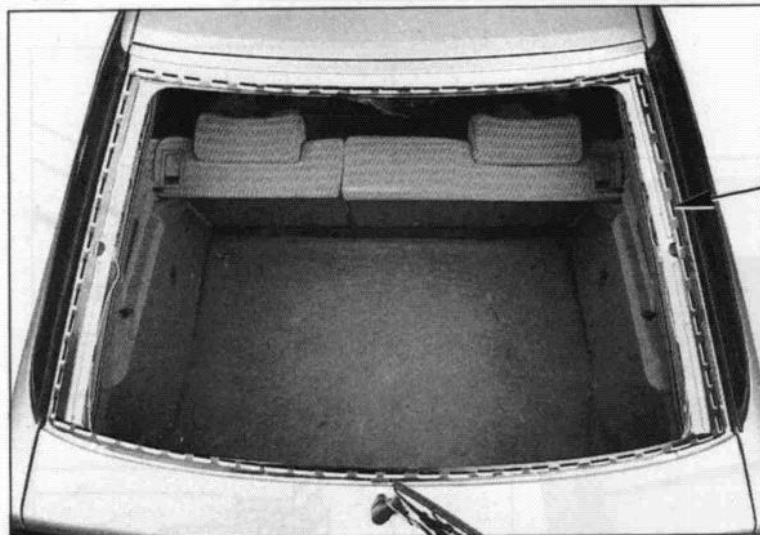

88-936

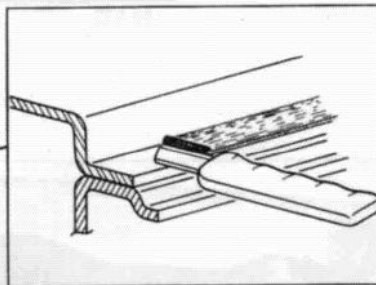

Z.96.4

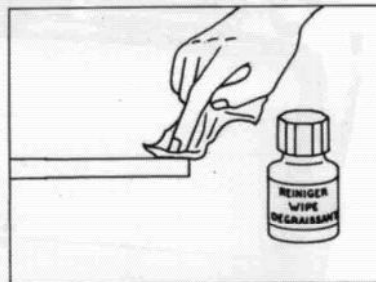

TT.96.1

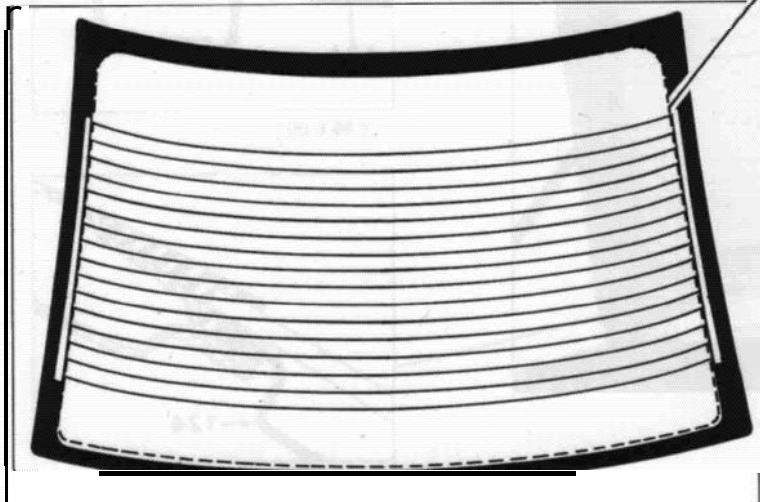

Y.96-7



15

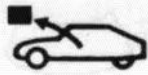

XM
845-3/1

5

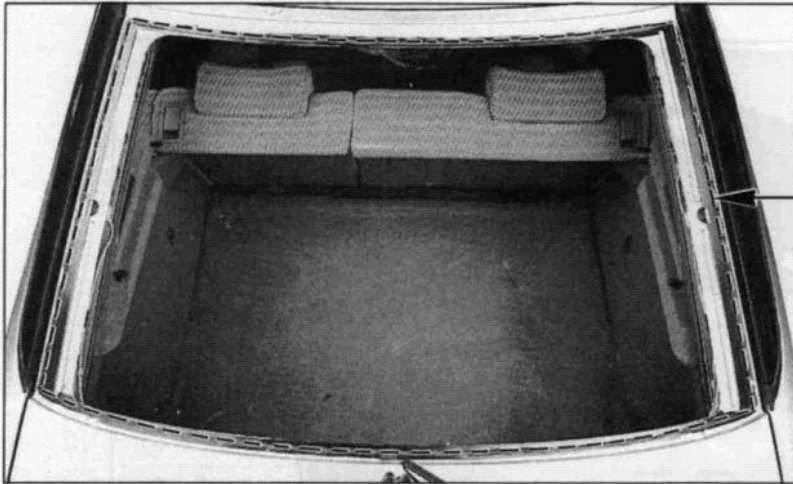

88-936

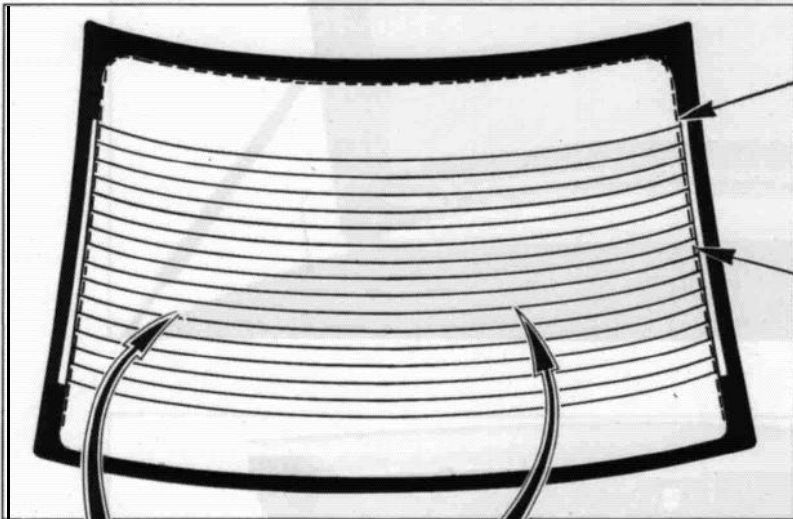

Y.96-7

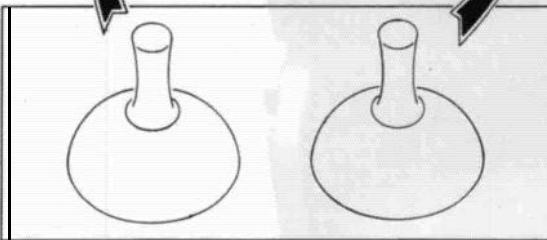

88-936

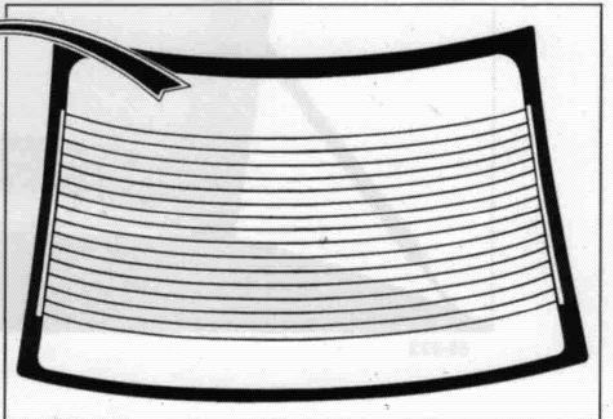
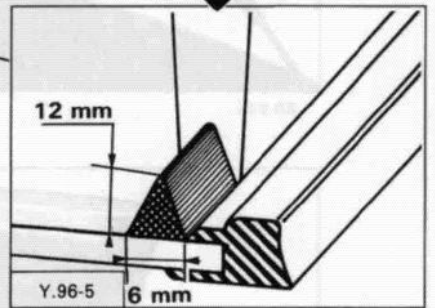
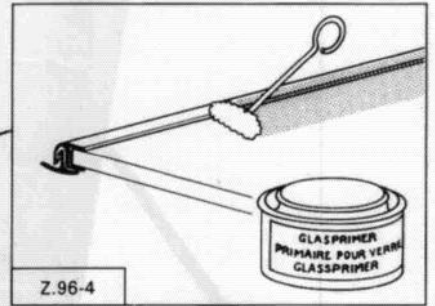
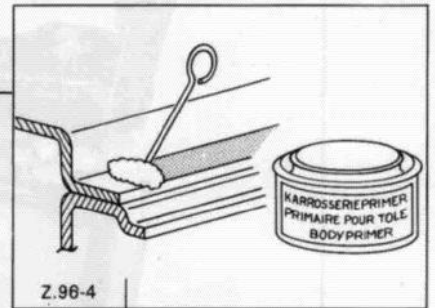

Y.96-7

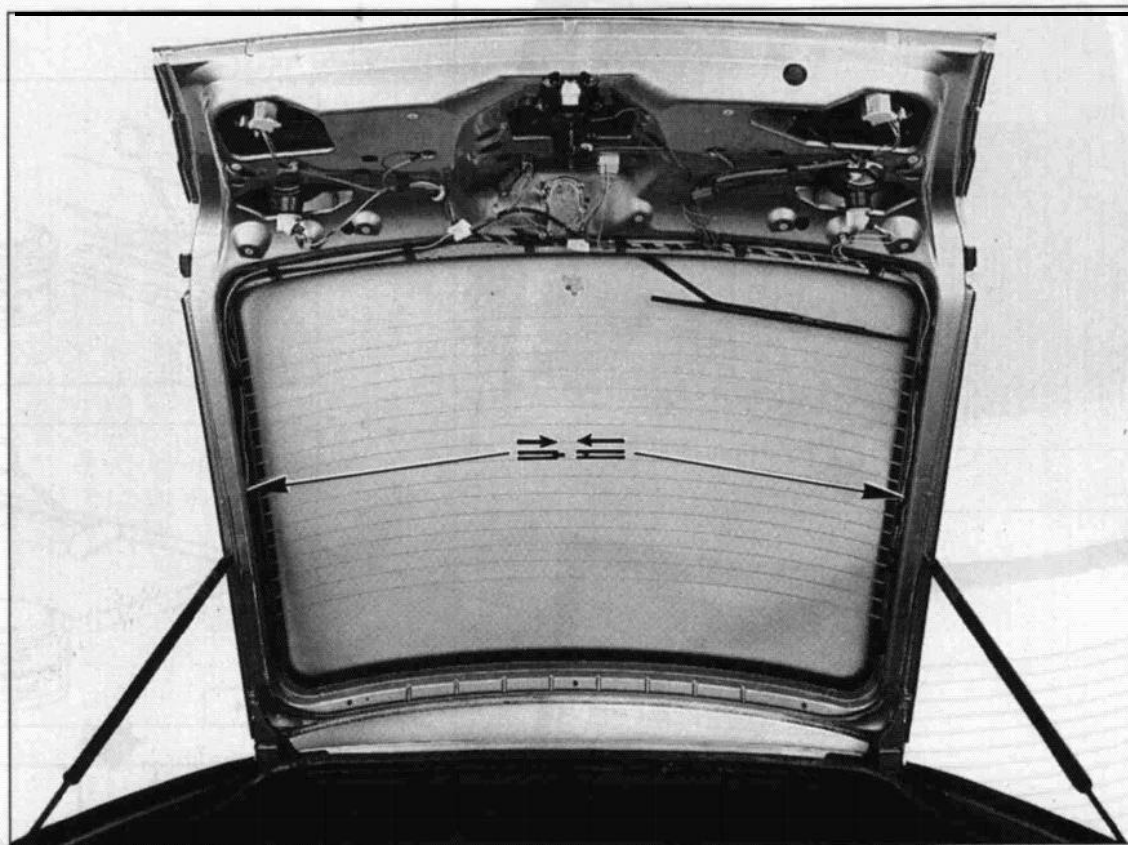
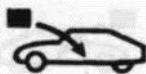
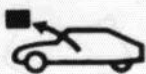

88-935

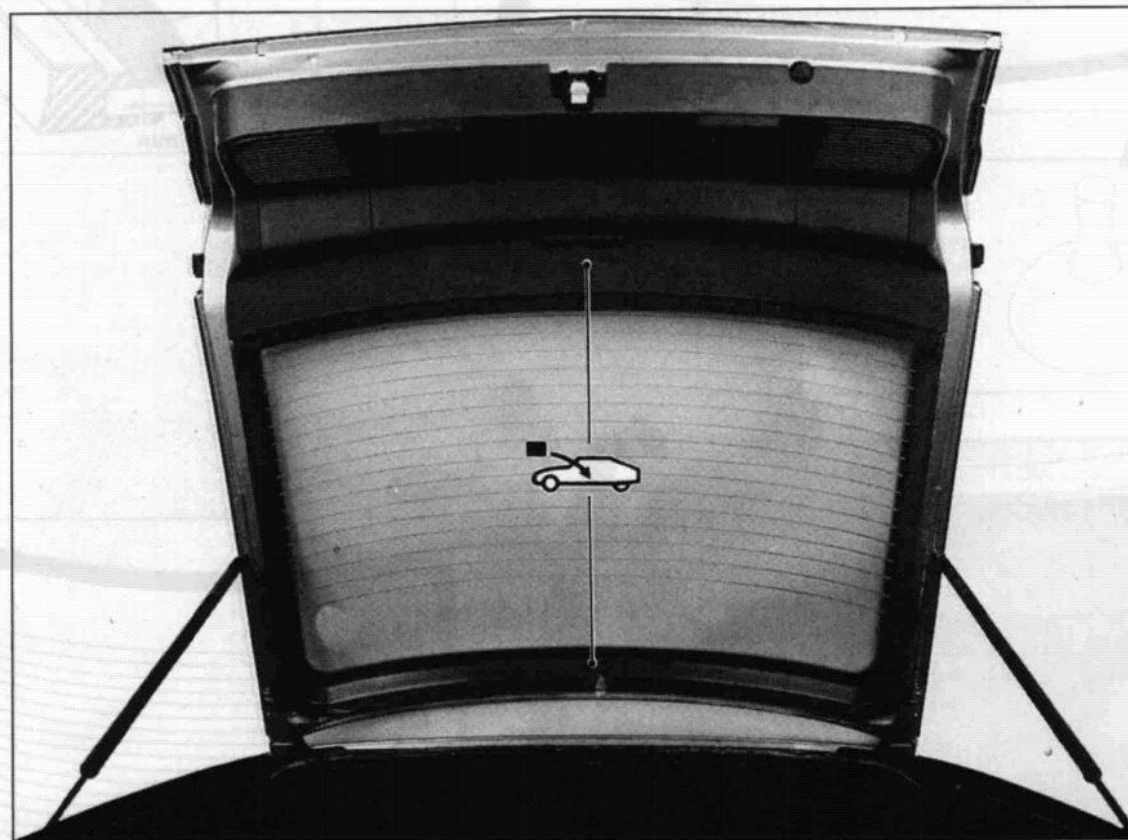

88-933